

ANÁLISIS ESTRUCTURAL

CELOSÍAS MADERA Y TECHO CLT

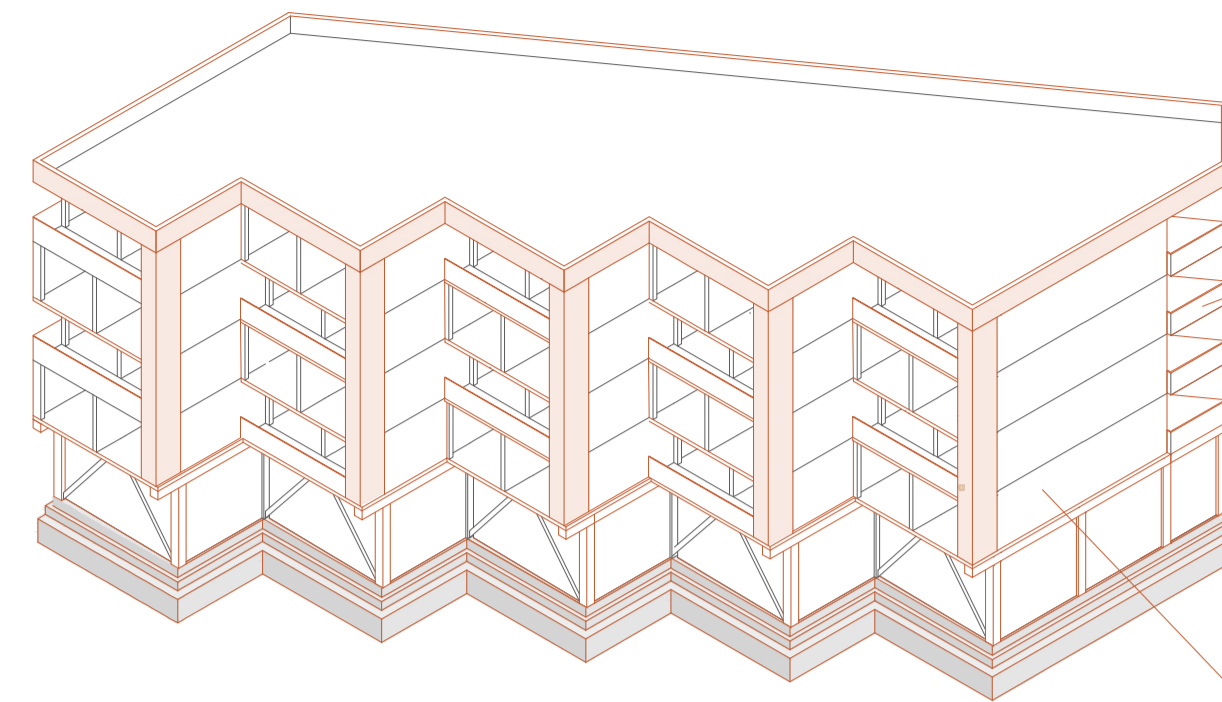

ESCALERAS Y BARANDAS

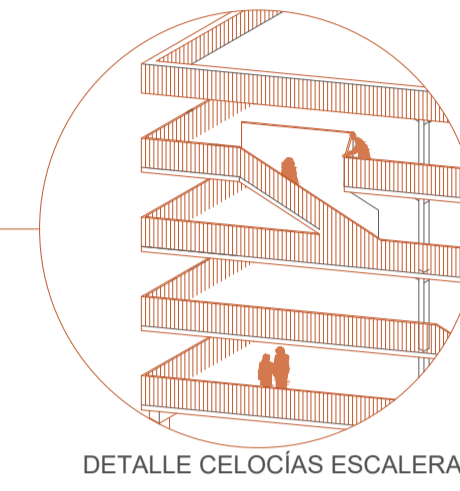
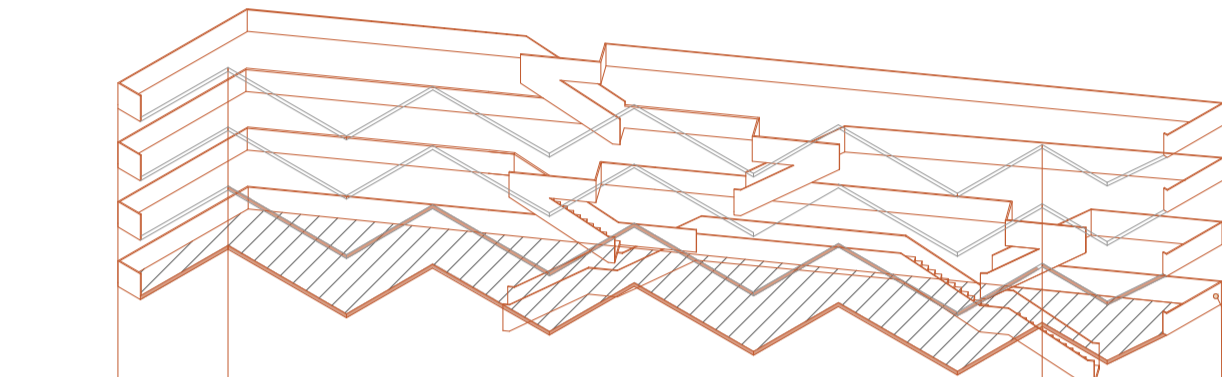

CERRAMIENTO MUROS TABIQUERÍA DE MADERA

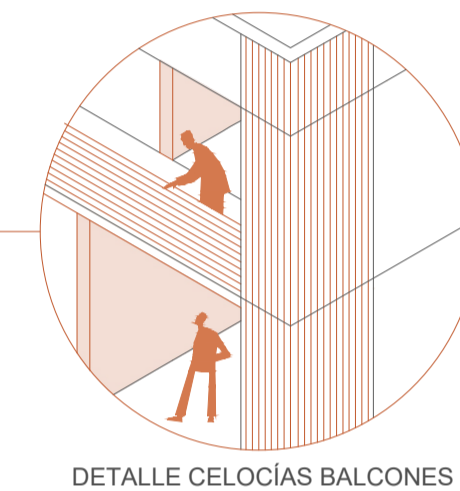
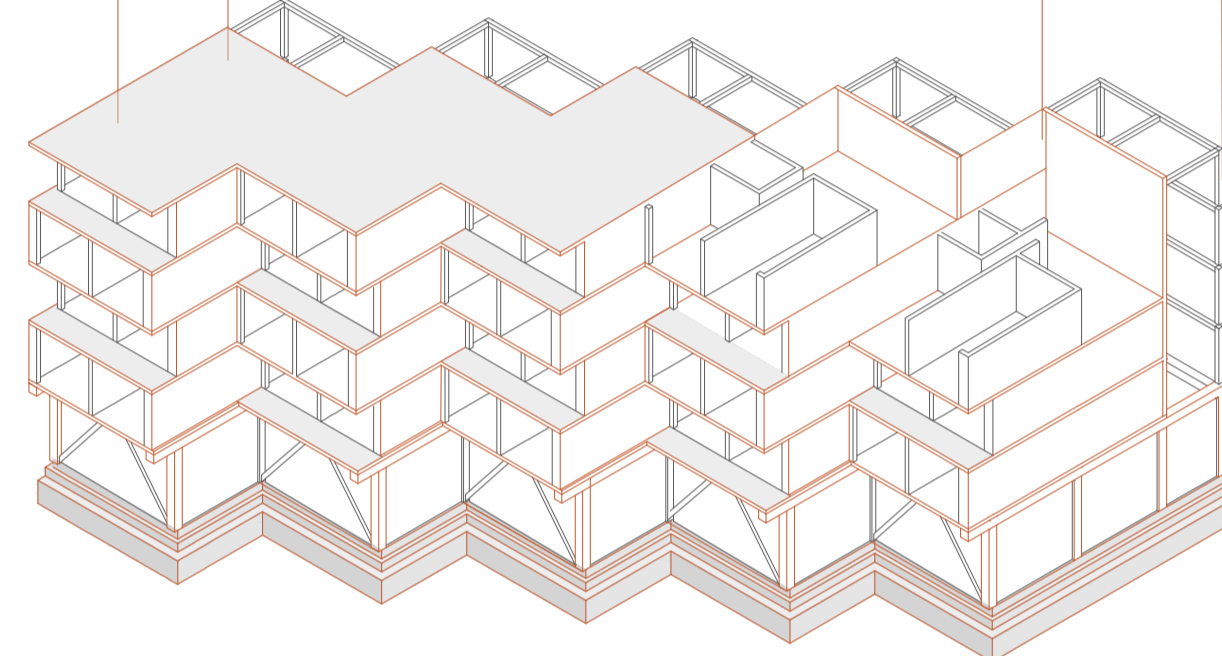

SUELO, TECHO Y MUROS ESTRUCTURALES DE CLT

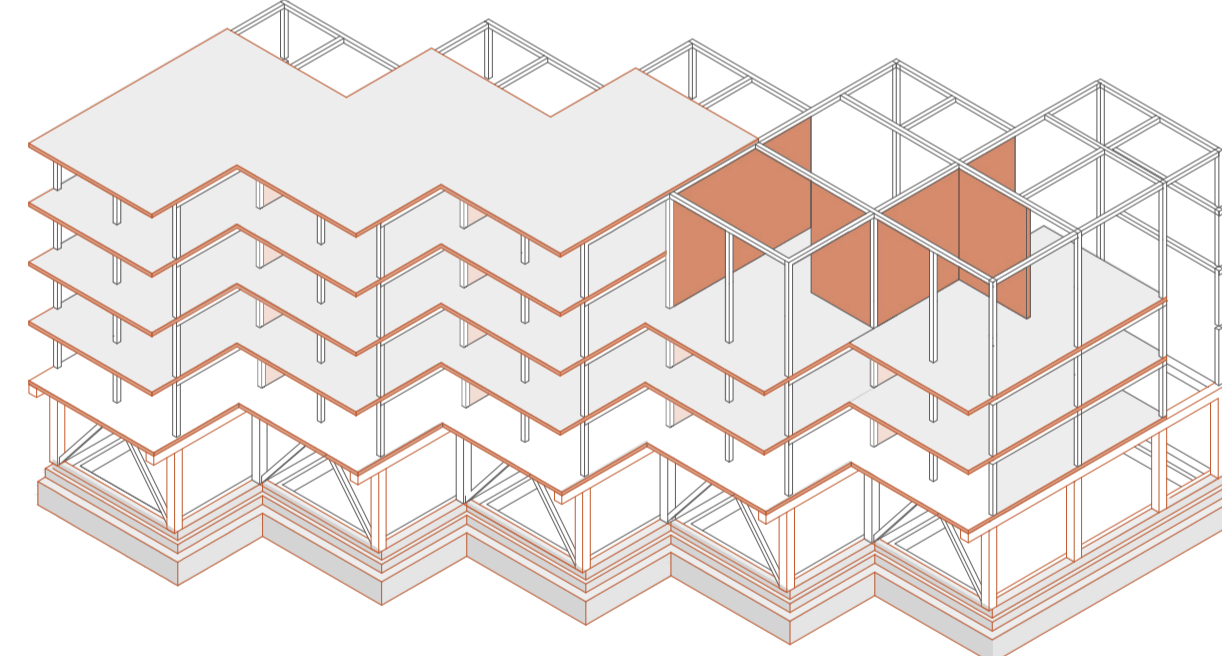

ENTRAMADO DE MADERA VIVIENDAS

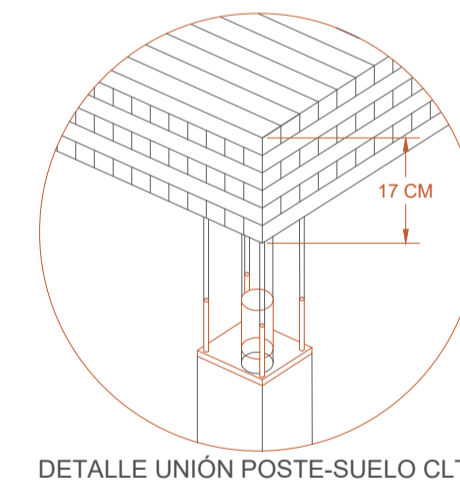
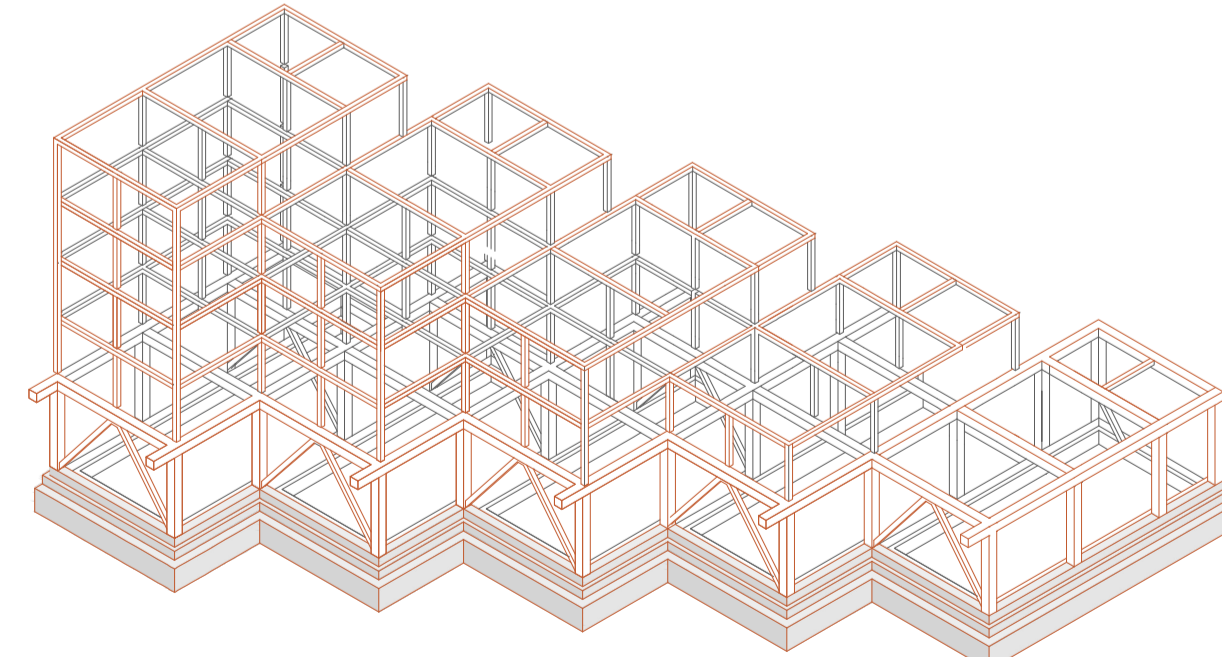

ENTRAMADO PORTANTE DE MADERA, ARRIOSTAMIENTO, FUNDACIONES HAY MUROS ESTRUCTURALES CLT

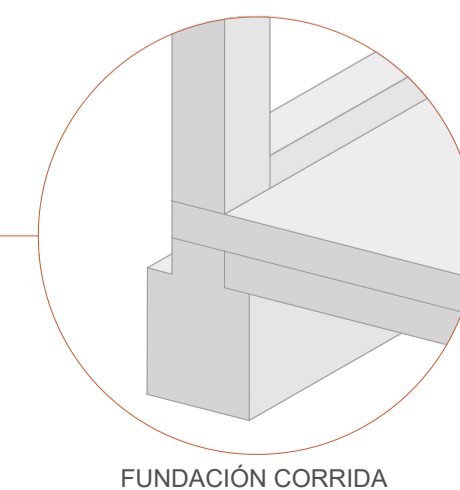
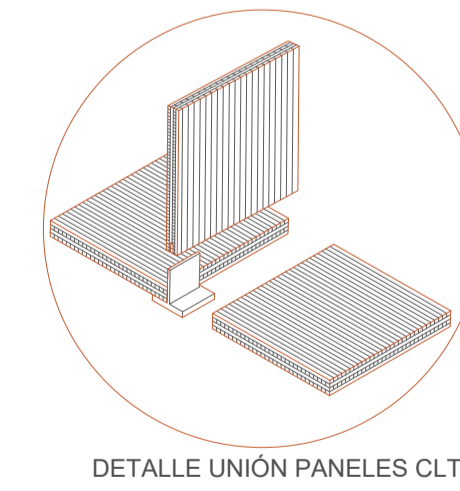
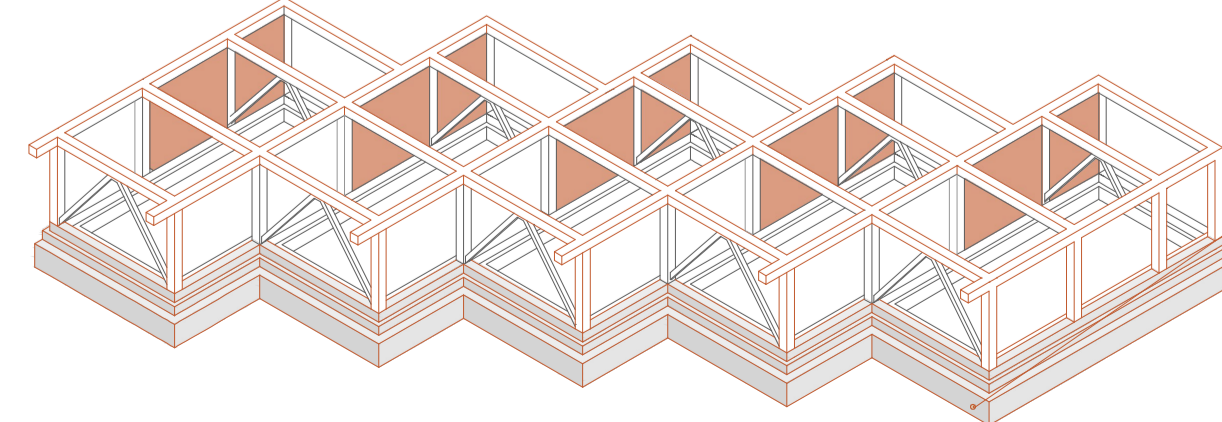

ESCANTILLÓN

